

TLE2426, TLE2426Y THE "RAIL SPLITTER" PRECISION VIRTUAL GROUND

SLOS098D – AUGUST 1991 – REVISED MAY 1998

- 1/2 V_I Virtual Ground for Analog Systems
- Self-Contained 3-terminal TO-226AA Package
- Micropower Operation . . . 170 μA Typ, $V_I = 5\text{ V}$
- Wide V_I Range . . . 4 V to 40 V
- High Output-Current Capability
 - Source . . . 20 mA Typ
 - Sink . . . 20 mA Typ
- Excellent Output Regulation
 - $-45\ \mu\text{V}$ Typ at $I_O = 0$ to $-10\ \text{mA}$
 - $+15\ \mu\text{V}$ Typ at $I_O = 0$ to $+10\ \text{mA}$
- Low-Impedance Output . . . $0.0075\ \Omega$ Typ
- Noise Reduction Pin (D, JG, and P Packages Only)

description

In signal-conditioning applications utilizing a single power source, a reference voltage equal to one-half the supply voltage is required for termination of all analog signal grounds. Texas Instruments presents a precision virtual ground whose output voltage is always equal to one-half the input voltage, the TLE2426 "rail splitter."

The unique combination of a high-performance, micropower operational amplifier and a precision-trimmed divider on a single silicon chip results in a precise V_O/V_I ratio of 0.5 while sinking and sourcing current. The TLE2426 provides a low-impedance output with 20 mA of sink and source capability while drawing less than 280 μA of supply current over the full input range of 4 V to 40 V. A designer need not pay the price in terms of board space for a conventional signal ground consisting of resistors, capacitors, operational amplifiers, and voltage references. The performance and precision of the TLE2426 is available in an easy-to-use, space saving, 3-terminal LP package. For increased performance, the optional 8-pin packages provide a noise-reduction pin. With the addition of an external capacitor (C_{NR}), peak-to-peak noise is reduced while line ripple rejection is improved.

Initial output tolerance for a single 5-V or 12-V system is better than 1% with 3.6% over the full 40-V input range. Ripple rejection exceeds 12 bits of accuracy. Whether the application is for a data acquisition front end, analog signal termination, or simply a precision voltage reference, the TLE2426 eliminates a major source of system error.

INPUT/OUTPUT TRANSFER CHARACTERISTICS

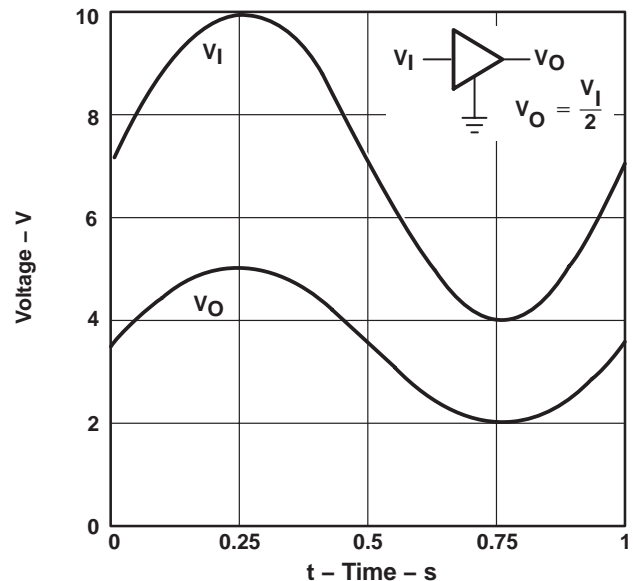

AVAILABLE OPTIONS

PACKAGED DEVICES					CHIP FORM (Y)
T_A	SMALL OUTLINE (D)	CERAMIC DIP (JG)	PLASTIC (LP)	PLASTIC DIP (P)	
0°C to 70°C	TLE2426CD	—	TLE2426CLP	TLE2426CP	



Please be aware that an important notice concerning availability, standard warranty, and use in critical applications of Texas Instruments semiconductor products and disclaimers thereto appears at the end of this data sheet.

PRODUCTION DATA information is current as of publication date. Products conform to specifications per the terms of Texas Instruments standard warranty. Production processing does not necessarily include testing of all parameters.



POST OFFICE BOX 655303 • DALLAS, TEXAS 75265

Copyright © 1998, Texas Instruments Incorporated

TLE2426, TLE2426Y THE "RAIL SPLITTER" PRECISION VIRTUAL GROUND

SLOS098D – AUGUST 1991 – REVISED MAY 1998

-40°C to 85°C	TLE2426ID	—	TLE2426ILP	TLE2426IP	TLE2426Y
-55°C to 125°C	TLE2426MD	TLE2426MJG	TLE2426MLP	TLE2426MP	

The D and LP packages are available taped and reeled in the commercial temperature range only. Add R suffix to the device type (e. g., TLC2426CDR). Chips are tested at 25°C.



POST OFFICE BOX 655303 • DALLAS, TEXAS 75265

description (continued)

The C-suffix devices are characterized for operation from 0°C to 70°C. The I suffix devices are characterized for operation from -40°C to 85°C. The M suffix devices are characterized over the full military temperature range of -55°C to 125°C.

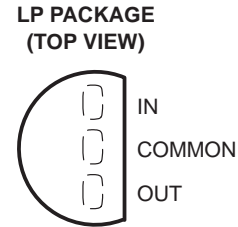
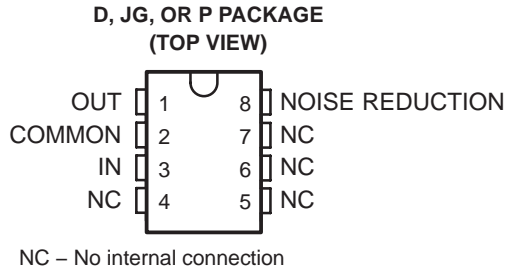

TLE2426Y chip information

This chip, properly assembled, displays characteristics similar to the TLE2426C. Thermal compression or ultrasonic bonding may be used on the doped aluminum bonding pads. The chips may be mounted with conductive epoxy or a gold-silicon preform.

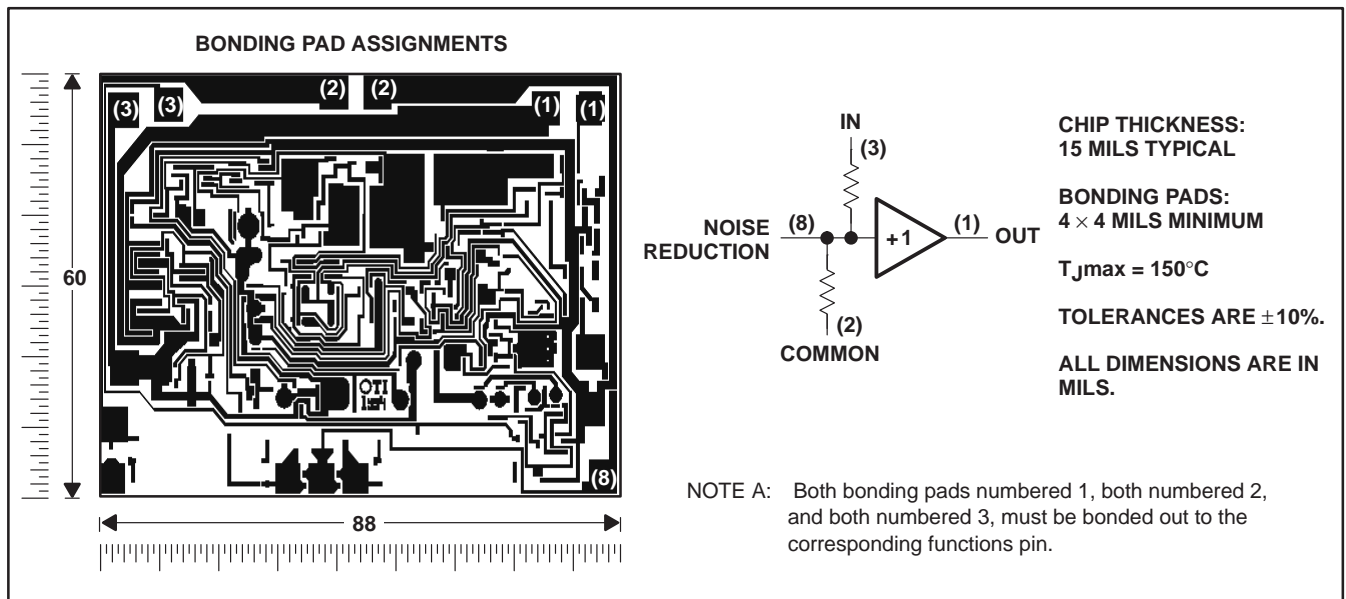

TLE2426, TLE2426Y
THE “RAIL SPLITTER”
PRECISION VIRTUAL GROUND

SLOS098D – AUGUST 1991 – REVISED MAY 1998

absolute maximum ratings over operating free-air temperature (unless otherwise noted)†

Continuous input voltage, V_I	40 V
Continuous filter trap voltage	40 V
Output current, I_O	± 80 mA
Duration of short-circuit current at (or below) 25°C (see Note 1)	unlimited
Continuous total power dissipation	See Dissipation Rating Table
Operating free-air temperature range, T_A : C suffix	0°C to 70°C
I suffix	-40°C to 85°C
M suffix	-55°C to 125°C
Storage temperature range, T_{stg}	-65°C to 150°C
Lead temperature 1,6 mm (1/16 inch) from case for 10 seconds: D or P package	260°C
Lead temperature 1,6 mm (1/16 inch) from case for 60 seconds: JG or LP package	300°C

† Stresses beyond those listed under “absolute maximum ratings” may cause permanent damage to the device. These are stress ratings only, and functional operation of the device at these or any other conditions beyond those indicated under “recommended operating conditions” is not implied. Exposure to absolute-maximum-rated conditions for extended periods may affect device reliability.

NOTE 1: The output may be shorted to either supply. Temperature and/or supply voltages must be limited to ensure that the maximum dissipation rating is not exceeded.

DISSIPATION RATING TABLE

PACKAGE	$T_A \leq 25^\circ\text{C}$	DERATING FACTOR ABOVE $T_A = 25^\circ\text{C}$	$T_A = 70^\circ\text{C}$	$T_A = 85^\circ\text{C}$	$T_A = 125^\circ\text{C}$
	POWER RATING		POWER RATING	POWER RATING	POWER RATING
D	725 mV	5.8 mW/°C	464 mW	377 mW	145 mW
JG	1050 mV	8.4 mW/°C	672 mW	546 mW	210 mW
LP	775 mV	6.2 mW/°C	496 mW	403 mW	155 mW
P	1000 mV	8.0 mW/°C	640 mW	520 mW	200 mW

recommended operating conditions

	C SUFFIX		I SUFFIX		M SUFFIX		UNIT
	MIN	MAX	MIN	MAX	MIN	MAX	
Input voltage, V_I	4	40	4	40	4	40	V
Operating free-air temperature, T_A	0	70	-40	85	-55	125	°C



electrical characteristics at specified free-air temperature, $V_I = 5\text{ V}$, $I_O = 0$ (unless otherwise noted)

PARAMETER	TEST CONDITIONS		T_A †	TLE2426C			UNIT
				MIN	TYP	MAX	
Output voltage	$V_I = 4\text{ V}$		25°C	1.98	2	2.02	V
	$V_I = 5\text{ V}$			2.48	2.5	2.52	
	$V_I = 40\text{ V}$			19.8	20	20.2	
	$V_I = 5\text{ V}$		Full range	2.475		2.525	
Temperature coefficient of output voltage			Full range	25		ppm/°C	
Supply current	No load	$V_I = 5\text{ V}$	25°C	170	300	µA	
		$V_I = 4\text{ to }40\text{ V}$	Full range	400			
Output voltage regulation (sourcing current)‡	$I_O = 0\text{ to }-10\text{ mA}$		25°C	-45	±160	µV	
			Full range	±250			
Output voltage regulation (sinking current)‡	$I_O = 0\text{ to }-20\text{ mA}$		25°C	-150	±450	µV	
			Full range	±250			
Output voltage regulation (sinking current)‡	$I_O = 0\text{ to }10\text{ mA}$		25°C	15	±160	µV	
			Full range	±250			
Output impedance			25°C	7.5	22.5	mΩ	
Noise-reduction impedance			25°C	110		kΩ	
Short-circuit current	Sinking current, $V_O = 5\text{ V}$		25°C	26		mA	
	Sourcing current, $V_O = 0$			-47			
Output noise voltage, rms	$f = 10\text{ Hz to }10\text{ kHz}$	$C_{NR} = 0$	25°C	120		µV	
		$C_{NR} = 1\text{ }\mu\text{F}$		30			
Output voltage current step response	$V_O\text{ to }0.1\%$, $I_O = \pm 10\text{ mA}$	$C_L = 0$	25°C	290		µs	
		$C_L = 100\text{ pF}$		275			
	$V_O\text{ to }0.01\%$, $I_O = \pm 10\text{ mA}$	$C_L = 0$	25°C	400			
		$C_L = 100\text{ pF}$		390			
Step response	$V_I = 0\text{ to }5\text{ V}$, $V_O\text{ to }0.1\%$		25°C	20		µs	
	$V_I = 0\text{ to }5\text{ V}$, $V_O\text{ to }0.01\%$			160			

† Full range is 0°C to 70°C.

‡ The listed values are not production tested.

TLE2426, TLE2426Y
THE “RAIL SPLITTER”
PRECISION VIRTUAL GROUND

SLOS098D – AUGUST 1991 – REVISED MAY 1998

electrical characteristics at specified free-air temperature, $V_I = 12\text{ V}$, $I_O = 0$ (unless otherwise noted)

PARAMETER	TEST CONDITIONS		T_A †	TLE2426C			UNIT
				MIN	TYP	MAX	
Output voltage	$V_I = 4\text{ V}$		25°C	1.98	2	2.02	V
	$V_I = 12\text{ V}$			5.95	6	6.05	
	$V_I = 40\text{ V}$			19.8	20	20.2	
	$V_I = 12\text{ V}$		Full range	5.945 6.055			
Temperature coefficient of output voltage			Full range	35		ppm/°C	
Supply current	No load	$V_I = 12\text{ V}$	25°C	195	300	μA	
		$V_I = 4\text{ to }40\text{ V}$	Full range	400			
Output voltage regulation (sourcing current)‡	$I_O = 0\text{ to }-10\text{ mA}$		25°C	-45	±160	μV	
			Full range	±250			
Output voltage regulation (sinking current)‡	$I_O = 0\text{ to }-20\text{ mA}$		25°C	-150	±450	μV	
			Full range	±250			
Output voltage regulation (sinking current)‡	$I_O = 0\text{ to }10\text{ mA}$		25°C	15	±160	μV	
			Full range	±250			
Output impedance			25°C	7.5	22.5	mΩ	
Noise-reduction impedance			25°C	110		kΩ	
Short-circuit current	Sinking current, $V_O = 12\text{ V}$		25°C	31		mA	
	Sourcing current, $V_O = 0$			-70			
Output noise voltage, rms	$f = 10\text{ Hz to }10\text{ kHz}$	$C_{NR} = 0$	25°C	120		μV	
		$C_{NR} = 1\text{ μF}$		30			
Output voltage current step response	$V_O\text{ to }0.1\%$, $I_O = \pm 10\text{ mA}$	$C_L = 0$	25°C	290		μs	
		$C_L = 100\text{ pF}$		275			
	$V_O\text{ to }0.01\%$, $I_O = \pm 10\text{ mA}$	$C_L = 0$	25°C	400			
		$C_L = 100\text{ pF}$		390			
Step response	$V_I = 0\text{ to }12\text{ V}$, $V_O\text{ to }0.1\%$		25°C	20		μs	
	$V_I = 0\text{ to }12\text{ V}$, $V_O\text{ to }0.01\%$			120			

† Full range is 0°C to 70°C.

‡ The listed values are not production tested.



electrical characteristics at specified free-air temperature, $V_I = 5\text{ V}$, $I_O = 0$ (unless otherwise noted)

PARAMETER	TEST CONDITIONS		T_A †	TLE2426I			UNIT
				MIN	TYP	MAX	
Output voltage	$V_I = 4\text{ V}$		25°C	1.98	2	2.02	V
	$V_I = 5\text{ V}$			2.48	2.5	2.52	
	$V_I = 40\text{ V}$			19.8	20	20.2	
	$V_I = 5\text{ V}$		Full range	2.47		2.53	
Temperature coefficient of output voltage			Full range	25		ppm/°C	
Supply current	No load	$V_I = 5\text{ V}$	25°C	170	300	µA	
		$V_I = 4\text{ to }40\text{ V}$	Full range	400			
Output voltage regulation (sourcing current)‡	$I_O = 0\text{ to }-10\text{ mA}$		25°C	-45	±160	µV	
			Full range	±250			
Output voltage regulation (sinking current)‡	$I_O = 0\text{ to }-20\text{ mA}$		25°C	-150	±450	µV	
	$I_O = 0\text{ to }10\text{ mA}$		25°C	15	±160		
	$I_O = 0\text{ to }8\text{ mA}$		Full range	±250			
Output voltage regulation (sinking current)‡	$I_O = 0\text{ to }20\text{ mA}$		25°C	65	±235	µV	
			Full range	±250			
Output impedance			25°C	7.5	22.5	mΩ	
Noise-reduction impedance			25°C	110		kΩ	
Short-circuit current	Sinking current,	$V_O = 5\text{ V}$	25°C	26		mA	
	Sourcing current,	$V_O = 0$		-47			
Output noise voltage, rms	$f = 10\text{ Hz to }10\text{ kHz}$	$C_{NR} = 0$	25°C	120		µV	
		$C_{NR} = 1\text{ µF}$		30			
Output voltage current step response	$V_O\text{ to }0.1\%$, $I_O = \pm 10\text{ mA}$	$C_L = 0$	25°C	290		µs	
		$C_L = 100\text{ pF}$		275			
	$V_O\text{ to }0.01\%$, $I_O = \pm 10\text{ mA}$	$C_L = 0$	25°C	400			
		$C_L = 100\text{ pF}$		390			
Step response	$V_I = 0\text{ to }5\text{ V}$, $V_O\text{ to }0.1\%$	$C_L = 100\text{ pF}$	25°C	20		µs	
	$V_I = 0\text{ to }5\text{ V}$, $V_O\text{ to }0.01\%$			160			

† Full range is -40°C to 85°C.

‡ The listed values are not production tested.

TLE2426, TLE2426Y
THE “RAIL SPLITTER”
PRECISION VIRTUAL GROUND

SLOS098D – AUGUST 1991 – REVISED MAY 1998

electrical characteristics at specified free-air temperature, $V_I = 12\text{ V}$, $I_O = 0$ (unless otherwise noted)

PARAMETER	TEST CONDITIONS		T_A^\dagger	TLE2426I			UNIT
				MIN	TYP	MAX	
Output voltage	$V_I = 4\text{ V}$		25°C	1.98	2	2.02	V
	$V_I = 12\text{ V}$			5.95	6	6.05	
	$V_I = 40\text{ V}$			19.8	20	20.2	
	$V_I = 12\text{ V}$		Full range	5.935		6.065	
Temperature coefficient of output voltage			Full range	35		ppm/°C	
Supply current	No load	$V_I = 12\text{ V}$	25°C	195	300	µA	
		$V_I = 4\text{ to }40\text{ V}$	Full range	400			
Output voltage regulation (sourcing current) [‡]	$I_O = 0\text{ to }-10\text{ mA}$		25°C	-45	±160	µV	
			Full range	±250			
Output voltage regulation (sinking current) [‡]	$I_O = 0\text{ to }-20\text{ mA}$		25°C	-150	±450	µV	
			Full range	±250			
Output voltage regulation (sinking current) [‡]	$I_O = 0\text{ to }10\text{ mA}$		25°C	15	±160	µV	
	$I_O = 0\text{ to }8\text{ mA}$		Full range	±250			
	$I_O = 0\text{ to }20\text{ mA}$		25°C	65	±235		
Output impedance			25°C	7.5	22.5	mΩ	
Noise-reduction impedance			25°C	110		kΩ	
Short-circuit current	Sinking current, $V_O = 12\text{ V}$		25°C	31		mA	
	Sourcing current, $V_O = 0$			-70			
Output noise voltage, rms	$f = 10\text{ Hz to }10\text{ kHz}$	$C_{NR} = 0$	25°C	120		µV	
		$C_{NR} = 1\text{ µF}$		30			
Output voltage current step response	$V_O\text{ to }0.1\%$, $I_O = \pm 10\text{ mA}$	$C_L = 0$	25°C	290		µs	
		$C_L = 100\text{ pF}$		275			
	$V_O\text{ to }0.01\%$, $I_O = \pm 10\text{ mA}$	$C_L = 0$	25°C	400			
		$C_L = 100\text{ pF}$		390			
Step response	$V_I = 0\text{ to }12\text{ V}$, $V_O\text{ to }0.1\%$		25°C	20		µs	
	$V_I = 0\text{ to }12\text{ V}$, $V_O\text{ to }0.01\%$			120			

[†] Full range is -40°C to 85°C.

[‡] The listed values are not production tested.



electrical characteristics at specified free-air temperature, $V_I = 5\text{ V}$, $I_O = 0$ (unless otherwise noted)

PARAMETER	TEST CONDITIONS		T_A †	TLE2426M			UNIT
				MIN	TYP	MAX	
Output voltage	$V_I = 4\text{ V}$		25°C	1.98	2	2.02	V
	$V_I = 5\text{ V}$			2.48	2.5	2.52	
	$V_I = 40\text{ V}$			19.8	20	20.2	
	$V_I = 5\text{ V}$		Full range	2.465 2.535			
Temperature coefficient of output voltage			Full range	25		ppm/°C	
Supply current	No load	$V_I = 5\text{ V}$	25°C	170	300	µA	
		$V_I = 4\text{ to }40\text{ V}$	Full range	400			
Output voltage regulation (sourcing current)‡	$I_O = 0\text{ to }-10\text{ mA}$		25°C	-45	±160	µV	
			Full range	±250			
Output voltage regulation (sinking current)‡	$I_O = 0\text{ to }-20\text{ mA}$		25°C	-150	±450	µV	
			Full range	±250			
Output voltage regulation (sinking current)‡	$I_O = 0\text{ to }10\text{ mA}$		25°C	15	±160	µV	
	$I_O = 0\text{ to }3\text{ mA}$		Full range	±250			
	$I_O = 0\text{ to }20\text{ mA}$		25°C	65	±235		
Output impedance			25°C	7.5	22.5	mΩ	
Noise-reduction impedance			25°C	110		kΩ	
Short-circuit current	Sinking current, $V_O = 5\text{ V}$		25°C	26		mA	
	Sourcing current, $V_O = 0$			-47			
Output noise voltage, rms	$f = 10\text{ Hz to }10\text{ kHz}$	$C_{NR} = 0$	25°C	120		µV	
		$C_{NR} = 1\text{ µF}$		30			
Output voltage current step response	$V_O\text{ to }0.1\%$, $I_O = \pm 10\text{ mA}$	$C_L = 0$	25°C	290		µs	
		$C_L = 100\text{ pF}$		275			
	$V_O\text{ to }0.01\%$, $I_O = \pm 10\text{ mA}$	$C_L = 0$	25°C	400			
		$C_L = 100\text{ pF}$		390			
Step response	$V_I = 0\text{ to }5\text{ V}$, $V_O\text{ to }0.1\%$		25°C	20		µs	
	$V_I = 0\text{ to }5\text{ V}$, $V_O\text{ to }0.01\%$			120			

† Full range is -55°C to 125°C.

‡ The listed values are not production tested.

TLE2426, TLE2426Y
THE “RAIL SPLITTER”
PRECISION VIRTUAL GROUND

SLOS098D – AUGUST 1991 – REVISED MAY 1998

electrical characteristics at specified free-air temperature, $V_I = 12\text{ V}$, $I_O = 0$ (unless otherwise noted)

PARAMETER	TEST CONDITIONS		T_A †	TLE2426M			UNIT
				MIN	TYP	MAX	
Output voltage	$V_I = 4\text{ V}$		25°C	1.98	2	2.02	V
	$V_I = 12\text{ V}$			5.95	6	6.05	
	$V_I = 40\text{ V}$			19.8	20	20.2	
	$V_I = 12\text{ V}$		Full range	5.925		6.075	
Temperature coefficient of output voltage			Full range	35		ppm/°C	
Supply current	No load	$V_I = 12\text{ V}$	25°C	195	250	µA	
		$V_I = 4\text{ to }40\text{ V}$	Full range	350			
Output voltage regulation (sourcing current)‡	$I_O = 0\text{ to }-10\text{ mA}$		25°C	-45	±160	µV	
			Full range	±250			
Output voltage regulation (sinking current)‡	$I_O = 0\text{ to }-20\text{ mA}$		25°C	-150	±450	µV	
			Full range	±250			
Output voltage regulation (sinking current)‡	$I_O = 0\text{ to }10\text{ mA}$		25°C	15	±160	µV	
	$I_O = 0\text{ to }8\text{ mA}$		Full range	±250			
	$I_O = 0\text{ to }20\text{ mA}$		25°C	65	±235		
Output impedance			25°C	7.5	22.5	mΩ	
Noise-reduction impedance			25°C	110		kΩ	
Short-circuit current	Sinking current,	$V_O = 12\text{ V}$	25°C	31		mA	
	Sourcing current,	$V_O = 0$		-70			
Output noise voltage, rms	$f = 10\text{ Hz to }10\text{ kHz}$	$C_{NR} = 0$	25°C	120		µV	
		$C_{NR} = 1\text{ µF}$		30			
Output voltage current step response	$V_O\text{ to }0.1\%$, $I_O = \pm 10\text{ mA}$	$C_L = 0$	25°C	290		µs	
		$C_L = 100\text{ pF}$		275			
	$V_O\text{ to }0.01\%$, $I_O = \pm 10\text{ mA}$	$C_L = 0$	25°C	400			
		$C_L = 100\text{ pF}$		390			
Step response	$V_I = 0\text{ to }12\text{ V}$, $V_O\text{ to }0.1\%$		25°C	12		µs	
	$V_I = 0\text{ to }12\text{ V}$, $V_O\text{ to }0.01\%$			120			

† Full range is -55°C to 125°C.

‡ The listed values are not production tested.



electrical characteristics at specified free-air temperature, $V_I = 5\text{ V}$, $I_O = 0$, $T_A = 25^\circ\text{C}$ (unless otherwise noted)

PARAMETER	TEST CONDITIONS	TLE2426Y			UNIT
		MIN	TYP	MAX	
Output voltage	$V_I = 5\text{ V}$	2.5			V
Supply current	No load	170			μA
Output voltage regulation (sourcing current) [†]	$I_O = 0$ to -10 mA	-45			μV
	$I_O = 0$ to -20 mA	-150			
Output voltage regulation (sinking current) [†]	$I_O = 0$ to 10 mA	15			μV
	$I_O = 0$ to 20 mA	65			
Output impedance		7.5			$\text{m}\Omega$
Noise-reduction impedance		110			$\text{k}\Omega$
Short-circuit current	Sinking current, $V_O = 5\text{ V}$	26			mA
	Sourcing current, $V_O = 0$	-47			
Output noise voltage, rms	$f = 10\text{ Hz}$ to 10 kHz	$C_{NR} = 0$	120		μV
		$C_{NR} = 1\ \mu\text{F}$	30		
Output voltage current step response	V_O to 0.1%, $I_O = \pm 10\text{ mA}$	$C_L = 0$	290		μs
		$C_L = 100\text{ pF}$	275		
	V_O to 0.01%, $I_O = \pm 10\text{ mA}$	$C_L = 0$	400		
		$C_L = 100\text{ pF}$	390		
Step response	$V_I = 0$ to 5 V , V_O to 0.1%	$C_L = 100\text{ pF}$	20		μs
	$V_I = 0$ to 5 V , V_O to 0.01%		160		

[†] The listed values are not production tested.

electrical characteristics at specified free-air temperature, $V_I = 12\text{ V}$, $I_O = 0$, $T_A = 25^\circ\text{C}$ (unless otherwise noted)

PARAMETER	TEST CONDITIONS	TLE2426Y			UNIT
		MIN	TYP	MAX	
Output voltage	$V_I = 12\text{ V}$	6			V
Supply current	No load	195			μA
Output voltage regulation (sourcing current) [†]	$I_O = 0$ to -10 mA	-45			μV
	$I_O = 0$ to -20 mA	-150			
Output voltage regulation (sinking current) [†]	$I_O = 0$ to 3 mA	15			μV
	$I_O = 0$ to 20 mA	65			
Output impedance		7.5			$\text{m}\Omega$
Noise-reduction impedance		110			$\text{k}\Omega$
Short-circuit current	Sinking current, $V_O = 12\text{ V}$	31			mA
	Sourcing current, $V_O = 0$	-70			
Output noise voltage, rms	$f = 10\text{ Hz}$ to 10 kHz	$C_{NR} = 0$	120		μV
		$C_{NR} = 1\ \mu\text{F}$	30		
Output voltage current, step response	V_O to 0.1%, $I_O = \pm 10\text{ mA}$	$C_L = 0$	290		μs
		$C_L = 100\text{ pF}$	275		
	V_O to 0.01%, $I_O = \pm 10\text{ mA}$	$C_L = 0$	400		
		$C_L = 100\text{ pF}$	390		
Step response	$V_I = 0$ to 12 V , V_O to 0.1%	$C_L = 100\text{ pF}$	12		μs
	$V_I = 0$ to 12 V , V_O to 0.01%		120		

[†] The listed values are not production tested.

TYPICAL CHARACTERISTICS

Table Of Graphs

		FIGURE
Output voltage	Distribution	1,2
Output voltage change	vs Free-air temperature	3
Output voltage error	vs Input voltage	4
Input bias current	vs Input voltage	5
	vs Free-air temperature	6
Output voltage regulation	vs Output current	7
Output impedance	vs Frequency	8
Short-circuit output current	vs Input voltage	9,10
	vs Free-air temperature	11,12
Ripple rejection	vs Frequency	13
Spectral noise voltage density	vs Frequency	14
Output voltage response to output current step	vs Time	15
Output voltage power-up response	vs Time	16
Output current	vs Load capacitance	17

TYPICAL CHARACTERISTICS†

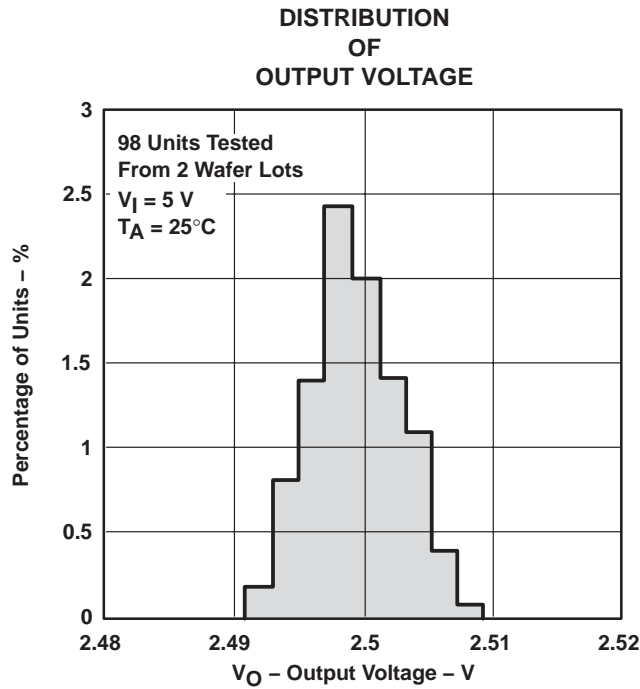

Figure 1

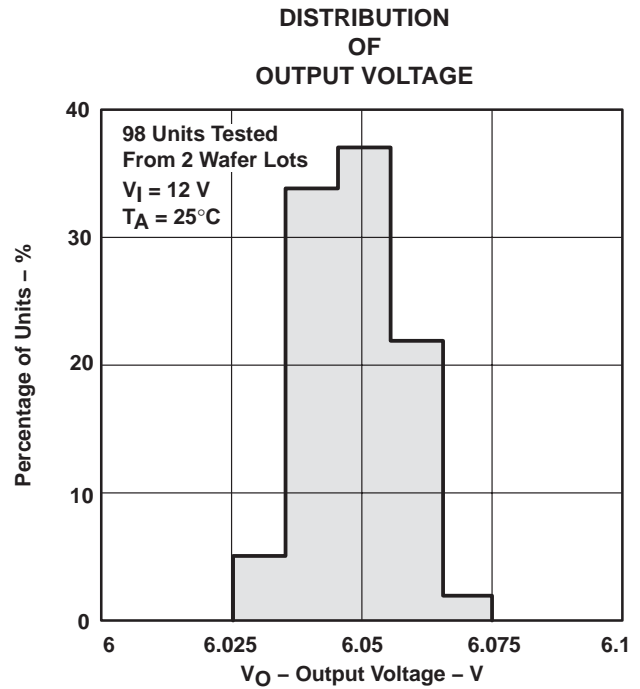

Figure 2

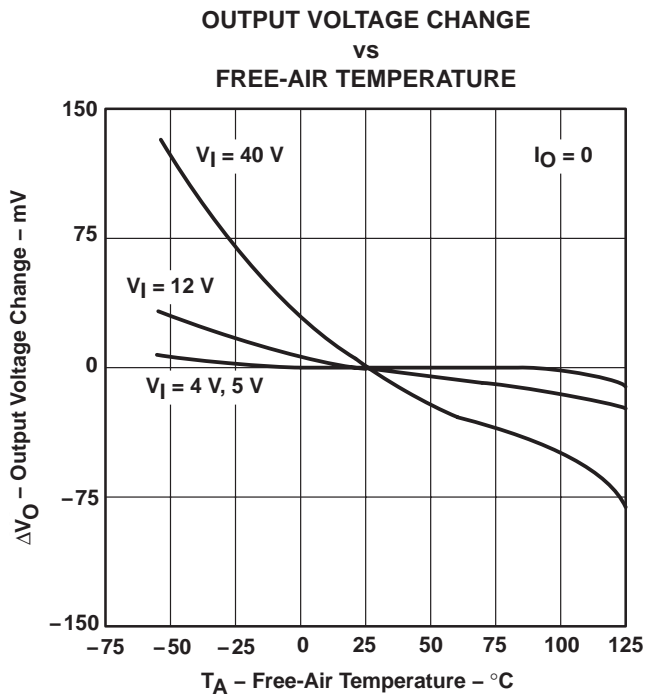

Figure 3

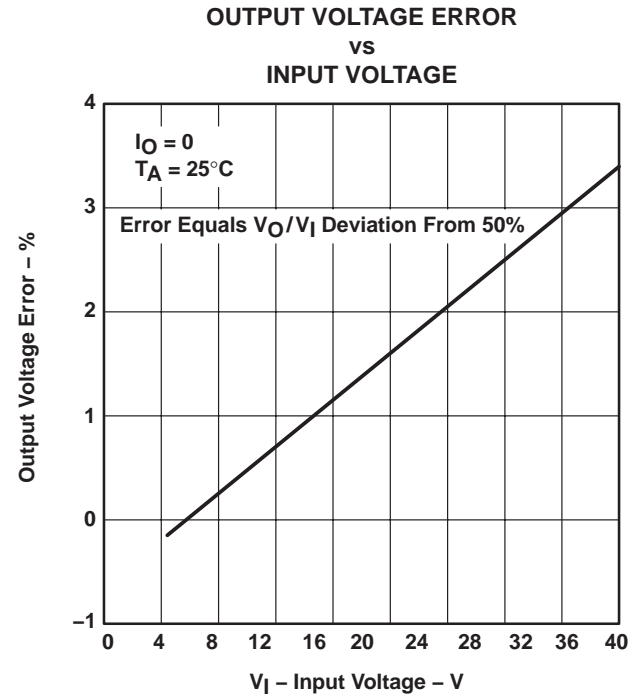

Figure 4

† Data at high and low temperatures are applicable within the rated operating free-air temperature ranges of the various devices.

TYPICAL CHARACTERISTICS†

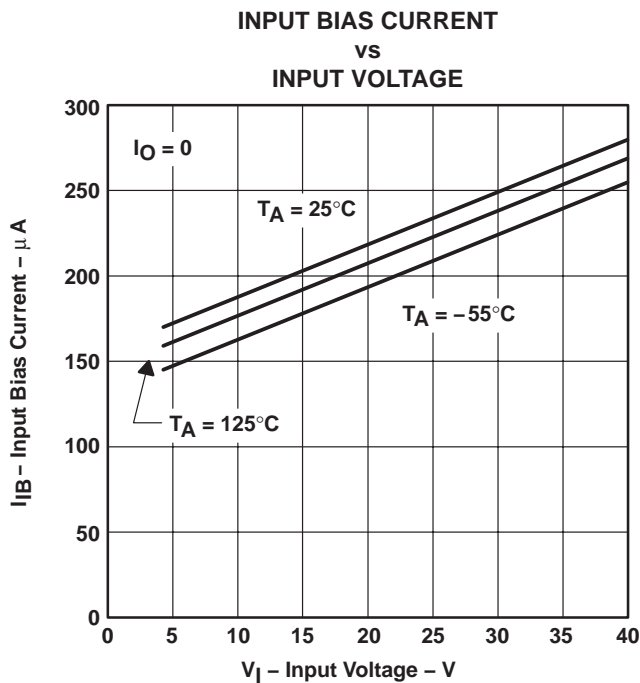

Figure 5

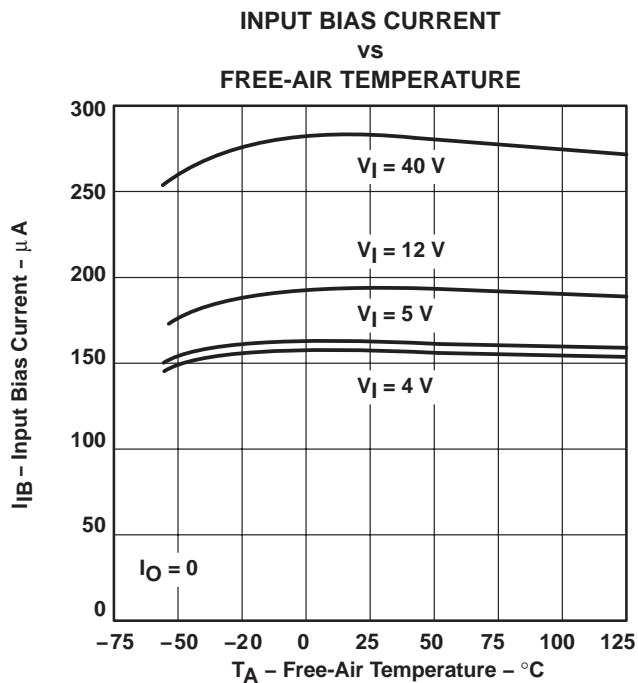

Figure 6

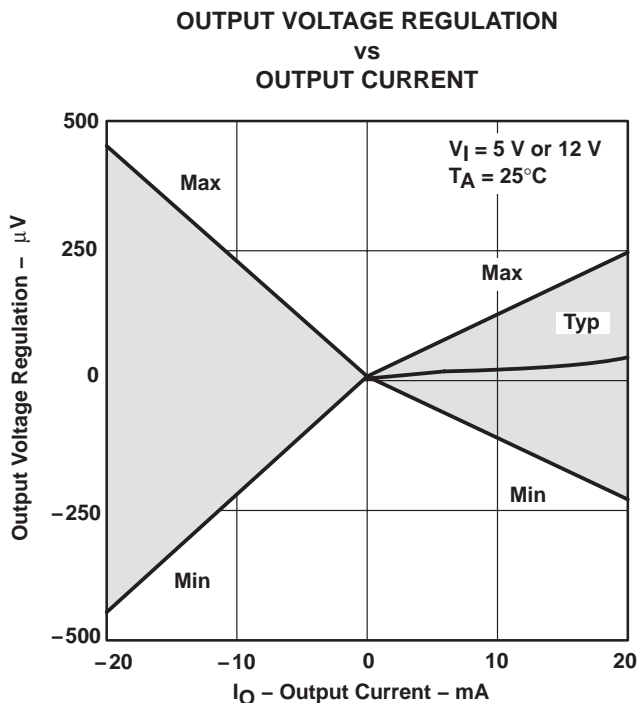

Figure 7

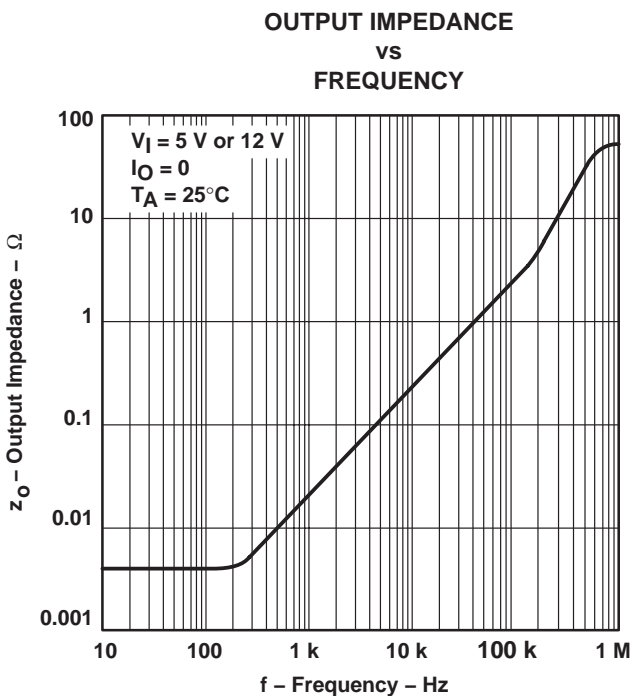

Figure 8

† Data at high and low temperatures are applicable within the rated operating free-air temperature ranges of the various devices.

TYPICAL CHARACTERISTICS†

SHORT-CIRCUIT OUTPUT CURRENT
 vs
 INPUT VOLTAGE

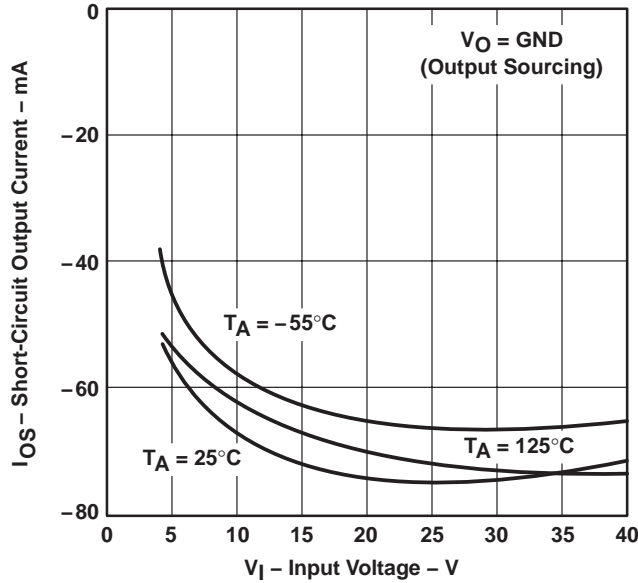

Figure 9

SHORT-CIRCUIT OUTPUT CURRENT
 vs
 INPUT VOLTAGE

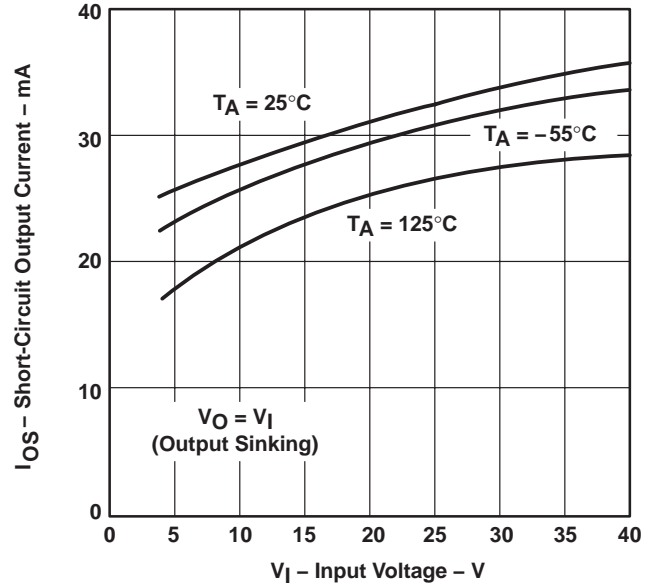

Figure 10

SHORT-CIRCUIT OUTPUT CURRENT
 vs
 FREE-AIR TEMPERATURE

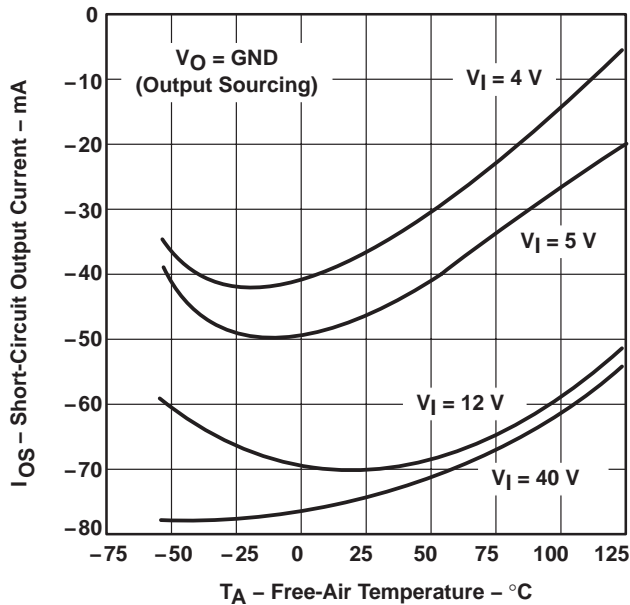

Figure 11

SHORT-CIRCUIT OUTPUT CURRENT
 vs
 FREE-AIR TEMPERATURE

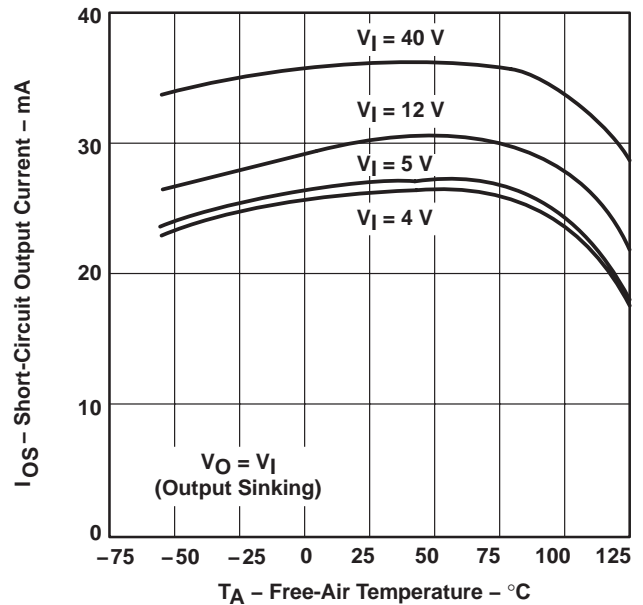

Figure 12

† Data at high and low temperatures are applicable within the rated operating free-air temperature ranges of the various devices.

TLE2426, TLE2426Y
THE "RAIL SPLITTER"
PRECISION VIRTUAL GROUND

SLOS098D – AUGUST 1991 – REVISED MAY 1998

TYPICAL CHARACTERISTICS

**RIPPLE REJECTION
 vs
 FREQUENCY**

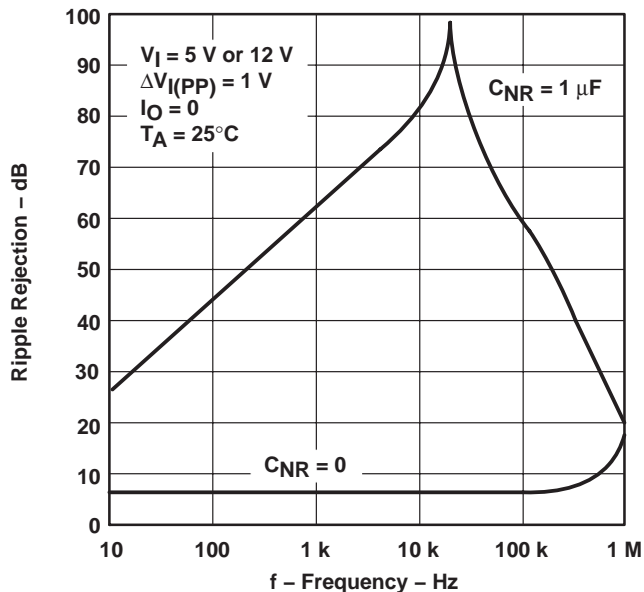

Figure 13

**SPECTRAL NOISE VOLTAGE DENSITY
 vs
 FREQUENCY**

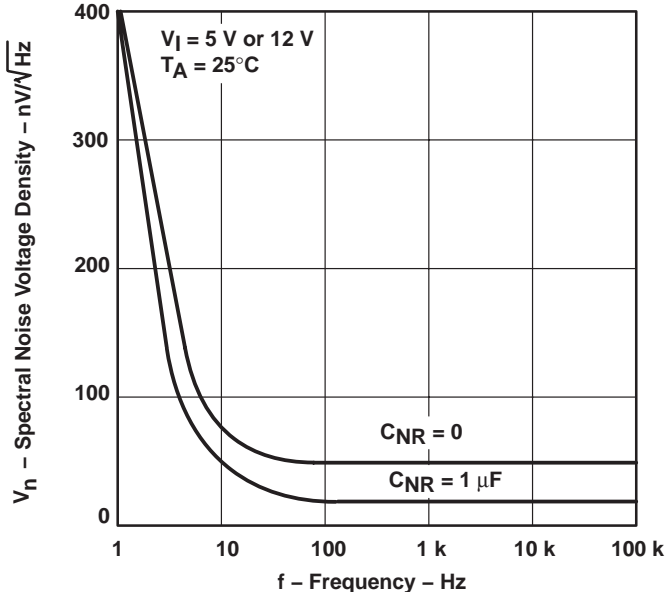

Figure 14

**OUTPUT VOLTAGE RESPONSE
 TO OUTPUT CURRENT STEP**

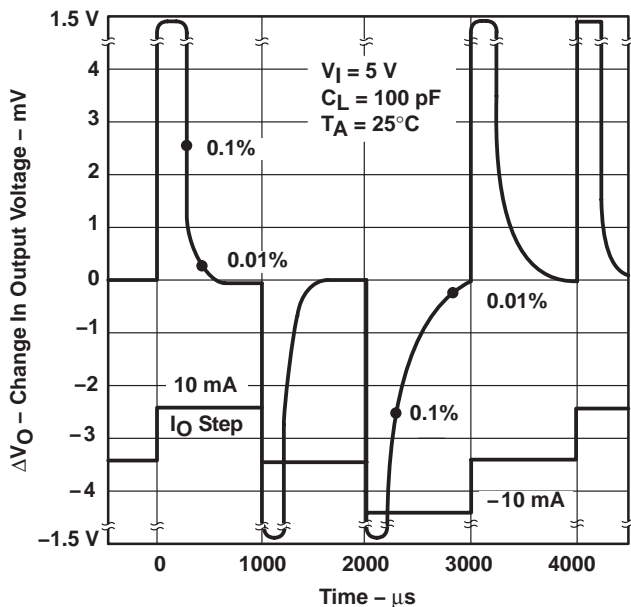

Figure 15

OUTPUT VOLTAGE POWER-UP RESPONSE

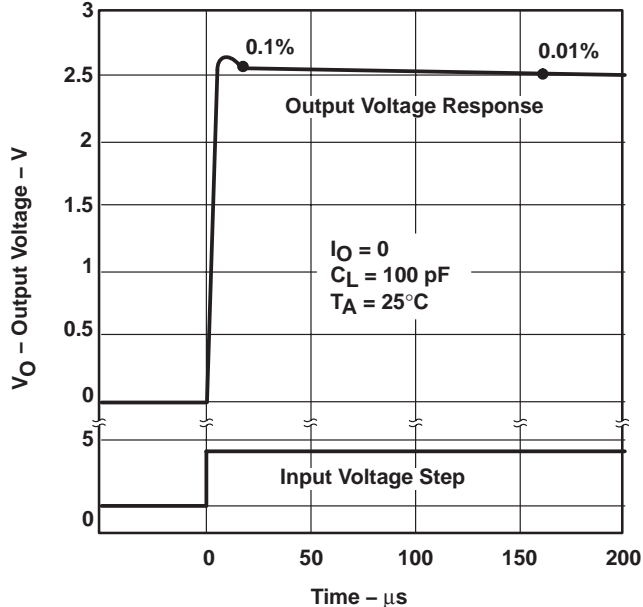

Figure 16



TYPICAL CHARACTERISTICS

STABILITY RANGE
OUTPUT CURRENT
VS
LOAD CAPACITANCE

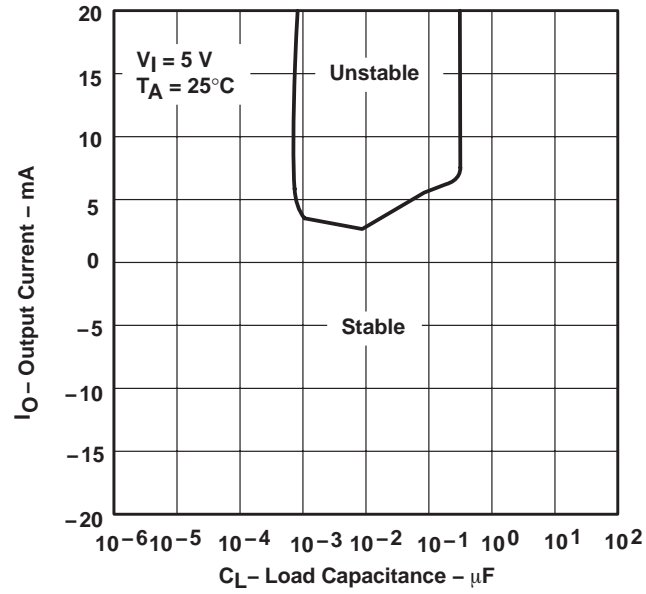

Figure 17

PACKAGING INFORMATION

Orderable Device	Status ⁽¹⁾	Package Type	Package Drawing	Pins	Package Qty	Eco Plan ⁽²⁾	Lead/Ball Finish	MSL Peak Temp ⁽³⁾
5962-9555602Q2A	OBSOLETE	LCCC	FK	20		TBD	Call TI	Call TI
5962-9555602QPA	OBSOLETE	CDIP	JG	8		TBD	Call TI	Call TI
TLE2426CD	ACTIVE	SOIC	D	8	75	Green (RoHS & no Sb/Br)	CU NIPDAU	Level-1-260C-UNLIM
TLE2426CDG4	ACTIVE	SOIC	D	8	75	Green (RoHS & no Sb/Br)	CU NIPDAU	Level-1-260C-UNLIM
TLE2426CDR	ACTIVE	SOIC	D	8	2500	Green (RoHS & no Sb/Br)	CU NIPDAU	Level-1-260C-UNLIM
TLE2426CDRG4	ACTIVE	SOIC	D	8	2500	Green (RoHS & no Sb/Br)	CU NIPDAU	Level-1-260C-UNLIM
TLE2426CLP	ACTIVE	TO-92	LP	3	1000	Pb-Free (RoHS)	CU SN	N / A for Pkg Type
TLE2426CLPE3	ACTIVE	TO-92	LP	3	1000	Pb-Free (RoHS)	CU SN	N / A for Pkg Type
TLE2426CLPR	ACTIVE	TO-92	LP	3	2000	Pb-Free (RoHS)	CU SN	N / A for Pkg Type
TLE2426CLPRE3	ACTIVE	TO-92	LP	3	2000	Pb-Free (RoHS)	CU SN	N / A for Pkg Type
TLE2426CP	ACTIVE	PDIP	P	8	50	Pb-Free (RoHS)	CU NIPDAU	N / A for Pkg Type
TLE2426CPE4	ACTIVE	PDIP	P	8	50	Pb-Free (RoHS)	CU NIPDAU	N / A for Pkg Type
TLE2426ID	ACTIVE	SOIC	D	8	75	Green (RoHS & no Sb/Br)	CU NIPDAU	Level-1-260C-UNLIM
TLE2426IDG4	ACTIVE	SOIC	D	8	75	Green (RoHS & no Sb/Br)	CU NIPDAU	Level-1-260C-UNLIM
TLE2426IDR	ACTIVE	SOIC	D	8	2500	Green (RoHS & no Sb/Br)	CU NIPDAU	Level-1-260C-UNLIM
TLE2426IDRG4	ACTIVE	SOIC	D	8	2500	Green (RoHS & no Sb/Br)	CU NIPDAU	Level-1-260C-UNLIM
TLE2426ILP	ACTIVE	TO-92	LP	3	1000	Pb-Free (RoHS)	CU SN	N / A for Pkg Type
TLE2426ILPE3	ACTIVE	TO-92	LP	3	1000	Pb-Free (RoHS)	CU SN	N / A for Pkg Type
TLE2426ILPR	ACTIVE	TO-92	LP	3	2000	Pb-Free (RoHS)	CU SN	N / A for Pkg Type
TLE2426ILPRE3	ACTIVE	TO-92	LP	3	2000	Pb-Free (RoHS)	CU SN	N / A for Pkg Type
TLE2426IP	ACTIVE	PDIP	P	8	50	Pb-Free (RoHS)	CU NIPDAU	N / A for Pkg Type
TLE2426IPE4	ACTIVE	PDIP	P	8	50	Pb-Free (RoHS)	CU NIPDAU	N / A for Pkg Type
TLE2426MD	ACTIVE	SOIC	D	8	75	TBD	CU NIPDAU	Level-1-220C-UNLIM
TLE2426MDG4	ACTIVE	SOIC	D	8	75	Green (RoHS & no Sb/Br)	CU NIPDAU	Level-1-260C-UNLIM
TLE2426MFKB	OBSOLETE	LCCC	FK	20		TBD	Call TI	Call TI
TLE2426MJGB	OBSOLETE	CDIP	JG	8		TBD	Call TI	Call TI
TLE2426MLP	OBSOLETE	TO-92	LP	3		TBD	Call TI	Call TI

Orderable Device	Status ⁽¹⁾	Package Type	Package Drawing	Pins	Package Qty	Eco Plan ⁽²⁾	Lead/Ball Finish	MSL Peak Temp ⁽³⁾
TLE2426MP	OBSOLETE	PDIP	P	8		TBD	Call TI	Call TI

⁽¹⁾ The marketing status values are defined as follows:

ACTIVE: Product device recommended for new designs.

LIFEBUY: TI has announced that the device will be discontinued, and a lifetime-buy period is in effect.

NRND: Not recommended for new designs. Device is in production to support existing customers, but TI does not recommend using this part in a new design.

PREVIEW: Device has been announced but is not in production. Samples may or may not be available.

OBSOLETE: TI has discontinued the production of the device.

⁽²⁾ Eco Plan - The planned eco-friendly classification: Pb-Free (RoHS), Pb-Free (RoHS Exempt), or Green (RoHS & no Sb/Br) - please check <http://www.ti.com/productcontent> for the latest availability information and additional product content details.

TBD: The Pb-Free/Green conversion plan has not been defined.

Pb-Free (RoHS): TI's terms "Lead-Free" or "Pb-Free" mean semiconductor products that are compatible with the current RoHS requirements for all 6 substances, including the requirement that lead not exceed 0.1% by weight in homogeneous materials. Where designed to be soldered at high temperatures, TI Pb-Free products are suitable for use in specified lead-free processes.

Pb-Free (RoHS Exempt): This component has a RoHS exemption for either 1) lead-based flip-chip solder bumps used between the die and package, or 2) lead-based die adhesive used between the die and leadframe. The component is otherwise considered Pb-Free (RoHS compatible) as defined above.

Green (RoHS & no Sb/Br): TI defines "Green" to mean Pb-Free (RoHS compatible), and free of Bromine (Br) and Antimony (Sb) based flame retardants (Br or Sb do not exceed 0.1% by weight in homogeneous material)

⁽³⁾ MSL, Peak Temp. -- The Moisture Sensitivity Level rating according to the JEDEC industry standard classifications, and peak solder temperature.

Important Information and Disclaimer:The information provided on this page represents TI's knowledge and belief as of the date that it is provided. TI bases its knowledge and belief on information provided by third parties, and makes no representation or warranty as to the accuracy of such information. Efforts are underway to better integrate information from third parties. TI has taken and continues to take reasonable steps to provide representative and accurate information but may not have conducted destructive testing or chemical analysis on incoming materials and chemicals. TI and TI suppliers consider certain information to be proprietary, and thus CAS numbers and other limited information may not be available for release.

In no event shall TI's liability arising out of such information exceed the total purchase price of the TI part(s) at issue in this document sold by TI to Customer on an annual basis.

OTHER QUALIFIED VERSIONS OF TLE2426 :

- Automotive: [TLE2426-Q1](#)
- Enhanced Product: [TLE2426-EP](#)

NOTE: Qualified Version Definitions:

- Automotive - Q100 devices qualified for high-reliability automotive applications targeting zero defects
- Enhanced Product - Supports Defense, Aerospace and Medical Applications

TAPE AND REEL INFORMATION



QUADRANT ASSIGNMENTS FOR PIN 1 ORIENTATION IN TAPE



*All dimensions are nominal

Device	Package Type	Package Drawing	Pins	SPQ	Reel Diameter (mm)	Reel Width W1 (mm)	A0 (mm)	B0 (mm)	K0 (mm)	P1 (mm)	W (mm)	Pin1 Quadrant
TLE2426CDR	SOIC	D	8	2500	330.0	12.4	6.4	5.2	2.1	8.0	12.0	Q1
TLE2426IDR	SOIC	D	8	2500	330.0	12.4	6.4	5.2	2.1	8.0	12.0	Q1

TAPE AND REEL BOX DIMENSIONS



*All dimensions are nominal

Device	Package Type	Package Drawing	Pins	SPQ	Length (mm)	Width (mm)	Height (mm)
TLE2426CDR	SOIC	D	8	2500	346.0	346.0	29.0
TLE2426IDR	SOIC	D	8	2500	346.0	346.0	29.0

FK (S-CQCC-N**)

LEADLESS CERAMIC CHIP CARRIER

28 TERMINAL SHOWN



4040140/D 10/96

- NOTES:
- A. All linear dimensions are in inches (millimeters).
 - B. This drawing is subject to change without notice.
 - C. This package can be hermetically sealed with a metal lid.
 - D. The terminals are gold plated.
 - E. Falls within JEDEC MS-004

D (R-PDSO-G8)

PLASTIC SMALL-OUTLINE PACKAGE

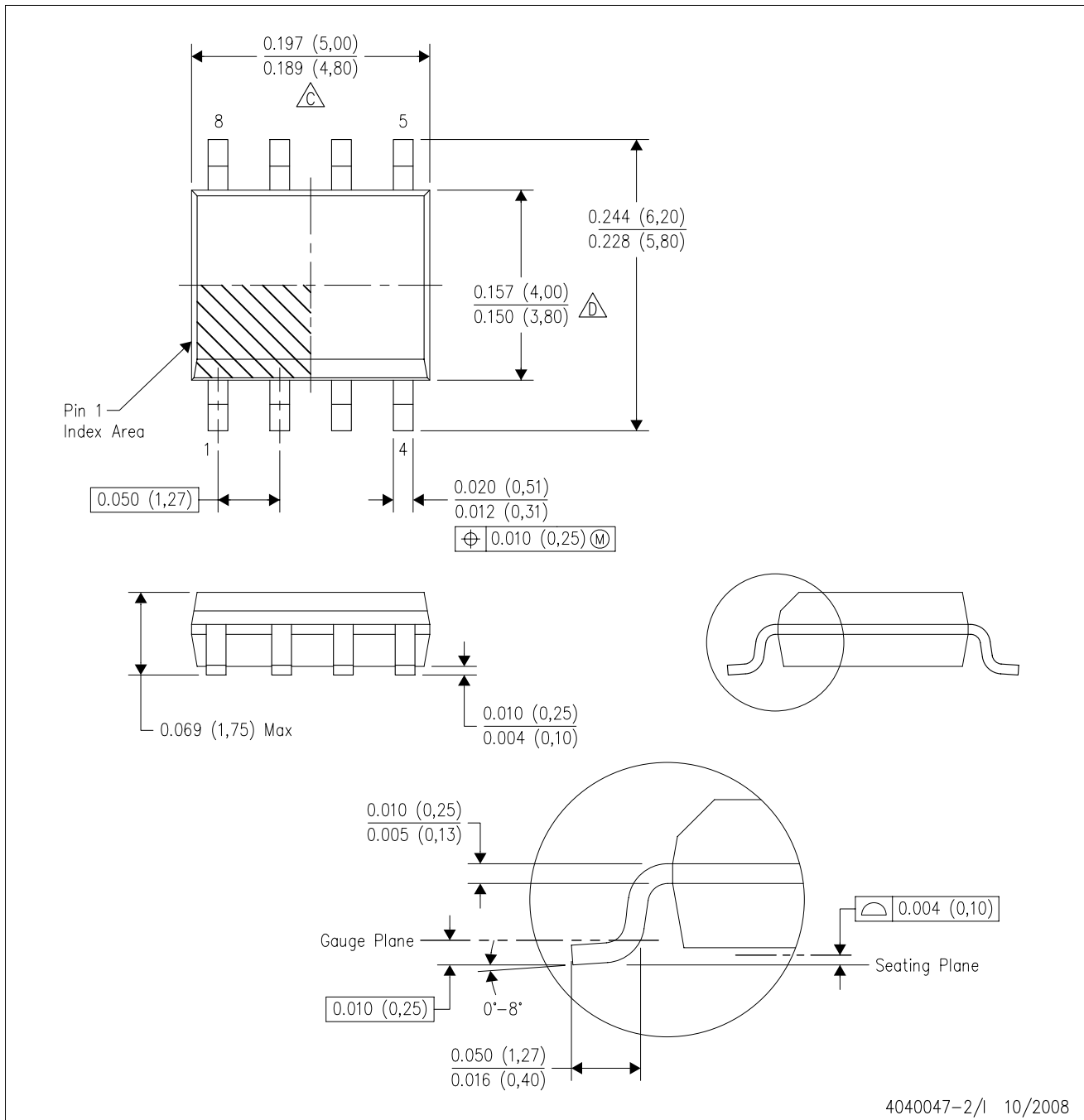

NOTES: A. All linear dimensions are in inches (millimeters).
 B. This drawing is subject to change without notice.
 C. Body length does not include mold flash, protrusions, or gate burrs. Mold flash, protrusions, or gate burrs shall not exceed .006 (0,15) per end.
 D. Body width does not include interlead flash. Interlead flash shall not exceed .017 (0,43) per side.
 E. Reference JEDEC MS-012 variation AA.

LP (O-PBCY-W3)

PLASTIC CYLINDRICAL PACKAGE

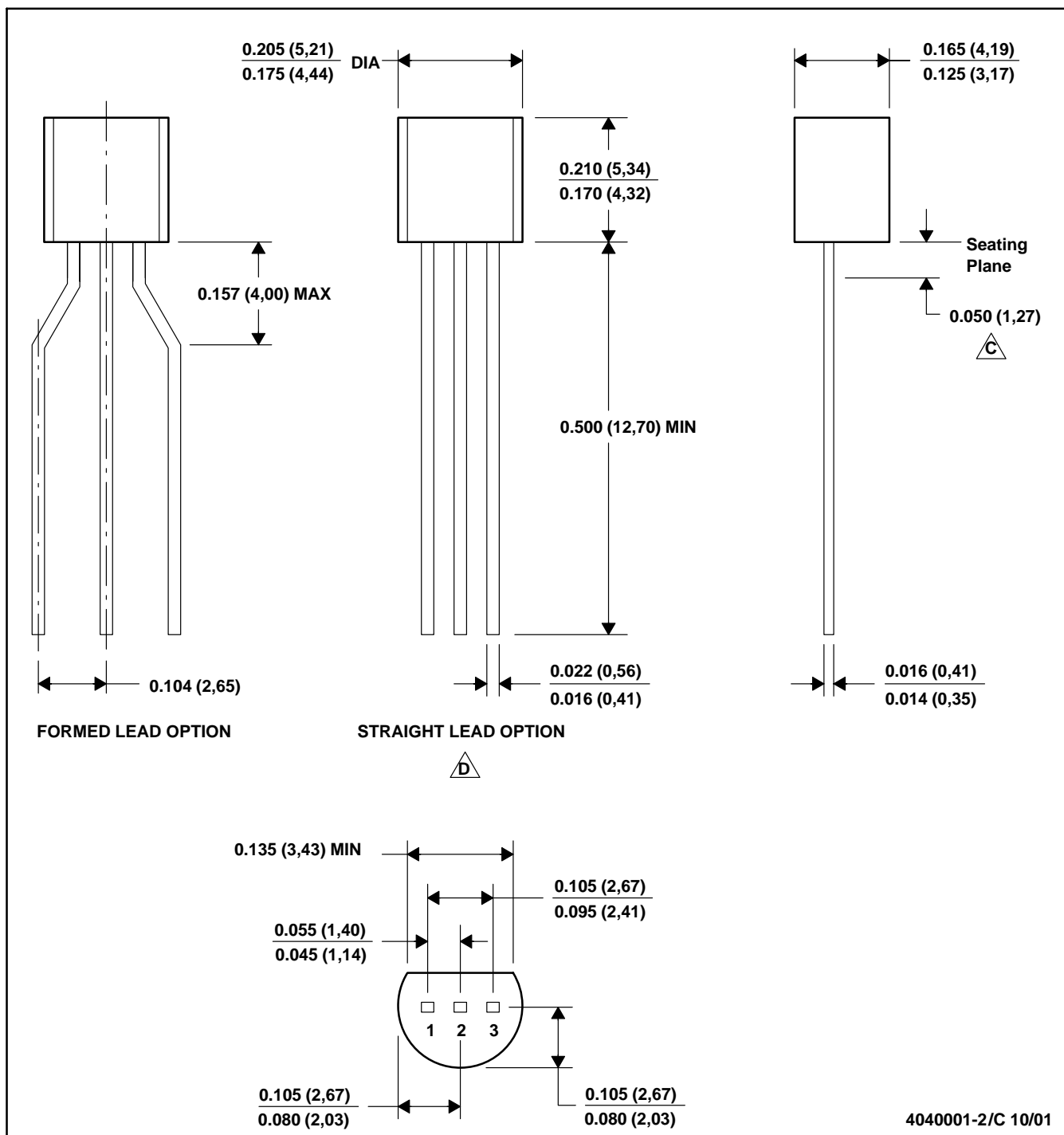

- NOTES: A. All linear dimensions are in inches (millimeters).
 B. This drawing is subject to change without notice.
 C. Lead dimensions are not controlled within this area
 D. Falls within JEDEC TO -226 Variation AA (TO-226 replaces TO-92)
 E. Shipping Method:
 Straight lead option available in bulk pack only.
 Formed lead option available in tape & reel or ammo pack.

MECHANICAL DATA

MSOT002A – OCTOBER 1994 – REVISED NOVEMBER 2001

LP (O-PBCY-W3)

PLASTIC CYLINDRICAL PACKAGE

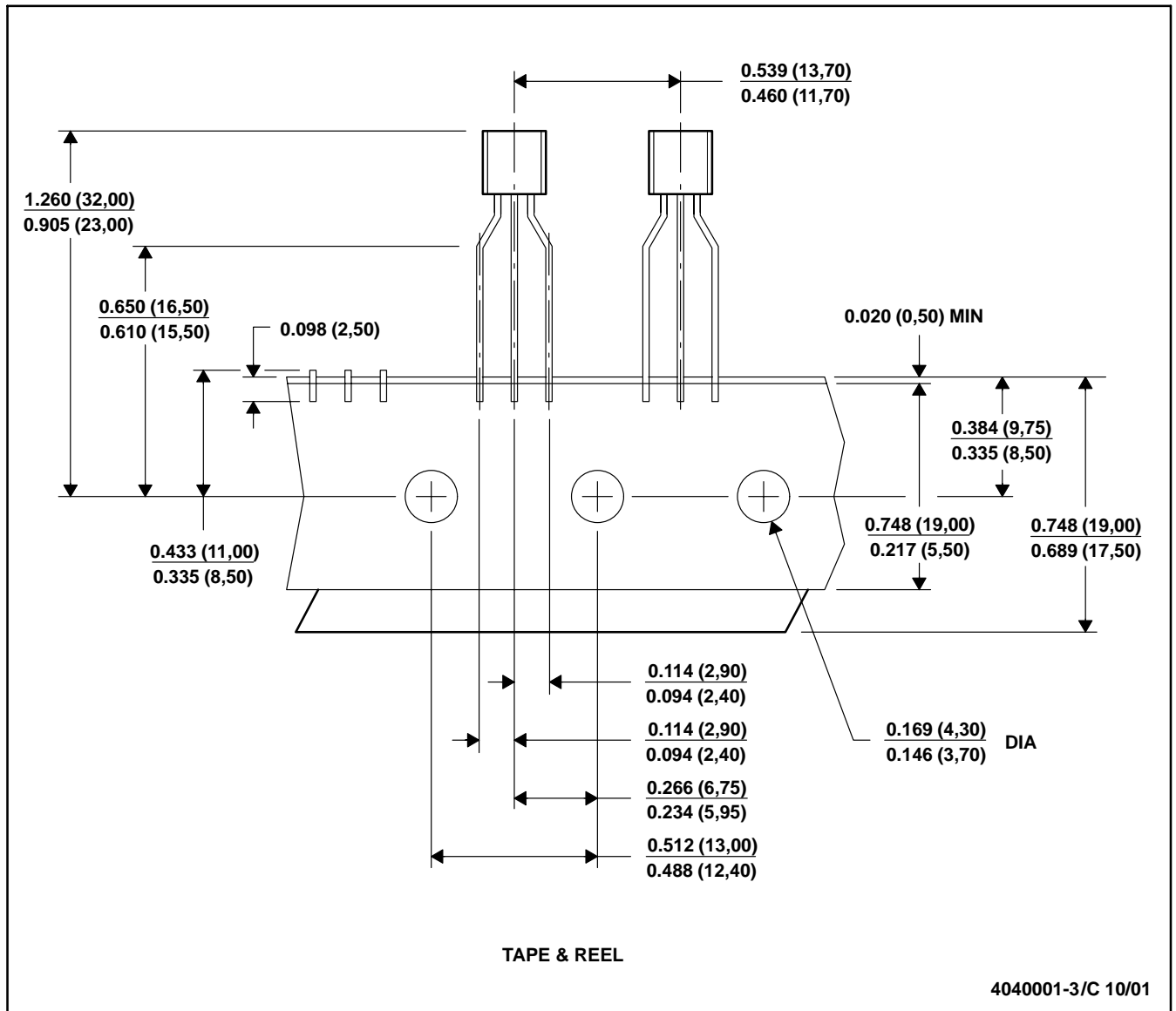

- NOTES: A. All linear dimensions are in inches (millimeters).
B. This drawing is subject to change without notice.
C. Tape and Reel information for the Format Lead Option package.

JG (R-GDIP-T8)

CERAMIC DUAL-IN-LINE



- NOTES: A. All linear dimensions are in inches (millimeters).
 B. This drawing is subject to change without notice.
 C. This package can be hermetically sealed with a ceramic lid using glass frit.
 D. Index point is provided on cap for terminal identification.
 E. Falls within MIL STD 1835 GDIP1-T8

P (R-PDIP-T8)

PLASTIC DUAL-IN-LINE



- NOTES: A. All linear dimensions are in inches (millimeters).
 B. This drawing is subject to change without notice.
 C. Falls within JEDEC MS-001

For the latest package information, go to http://www.ti.com/sc/docs/package/pkg_info.htm

IMPORTANT NOTICE

Texas Instruments Incorporated and its subsidiaries (TI) reserve the right to make corrections, modifications, enhancements, improvements, and other changes to its products and services at any time and to discontinue any product or service without notice. Customers should obtain the latest relevant information before placing orders and should verify that such information is current and complete. All products are sold subject to TI's terms and conditions of sale supplied at the time of order acknowledgment.

TI warrants performance of its hardware products to the specifications applicable at the time of sale in accordance with TI's standard warranty. Testing and other quality control techniques are used to the extent TI deems necessary to support this warranty. Except where mandated by government requirements, testing of all parameters of each product is not necessarily performed.

TI assumes no liability for applications assistance or customer product design. Customers are responsible for their products and applications using TI components. To minimize the risks associated with customer products and applications, customers should provide adequate design and operating safeguards.

TI does not warrant or represent that any license, either express or implied, is granted under any TI patent right, copyright, mask work right, or other TI intellectual property right relating to any combination, machine, or process in which TI products or services are used. Information published by TI regarding third-party products or services does not constitute a license from TI to use such products or services or a warranty or endorsement thereof. Use of such information may require a license from a third party under the patents or other intellectual property of the third party, or a license from TI under the patents or other intellectual property of TI.

Reproduction of TI information in TI data books or data sheets is permissible only if reproduction is without alteration and is accompanied by all associated warranties, conditions, limitations, and notices. Reproduction of this information with alteration is an unfair and deceptive business practice. TI is not responsible or liable for such altered documentation. Information of third parties may be subject to additional restrictions.

Resale of TI products or services with statements different from or beyond the parameters stated by TI for that product or service voids all express and any implied warranties for the associated TI product or service and is an unfair and deceptive business practice. TI is not responsible or liable for any such statements.

TI products are not authorized for use in safety-critical applications (such as life support) where a failure of the TI product would reasonably be expected to cause severe personal injury or death, unless officers of the parties have executed an agreement specifically governing such use. Buyers represent that they have all necessary expertise in the safety and regulatory ramifications of their applications, and acknowledge and agree that they are solely responsible for all legal, regulatory and safety-related requirements concerning their products and any use of TI products in such safety-critical applications, notwithstanding any applications-related information or support that may be provided by TI. Further, Buyers must fully indemnify TI and its representatives against any damages arising out of the use of TI products in such safety-critical applications.

TI products are neither designed nor intended for use in military/aerospace applications or environments unless the TI products are specifically designated by TI as military-grade or "enhanced plastic." Only products designated by TI as military-grade meet military specifications. Buyers acknowledge and agree that any such use of TI products which TI has not designated as military-grade is solely at the Buyer's risk, and that they are solely responsible for compliance with all legal and regulatory requirements in connection with such use.

TI products are neither designed nor intended for use in automotive applications or environments unless the specific TI products are designated by TI as compliant with ISO/TS 16949 requirements. Buyers acknowledge and agree that, if they use any non-designated products in automotive applications, TI will not be responsible for any failure to meet such requirements.

Following are URLs where you can obtain information on other Texas Instruments products and application solutions:

Products

Amplifiers	amplifier.ti.com
Data Converters	dataconverter.ti.com
DSP	dsp.ti.com
Clocks and Timers	www.ti.com/clocks
Interface	interface.ti.com
Logic	logic.ti.com
Power Mgmt	power.ti.com
Microcontrollers	microcontroller.ti.com
RFID	www.ti-rfid.com
RF/IF and ZigBee® Solutions	www.ti.com/lprf

Applications

Audio	www.ti.com/audio
Automotive	www.ti.com/automotive
Broadband	www.ti.com/broadband
Digital Control	www.ti.com/digitalcontrol
Medical	www.ti.com/medical
Military	www.ti.com/military
Optical Networking	www.ti.com/opticalnetwork
Security	www.ti.com/security
Telephony	www.ti.com/telephony
Video & Imaging	www.ti.com/video
Wireless	www.ti.com/wireless

Mailing Address: Texas Instruments, Post Office Box 655303, Dallas, Texas 75265
Copyright © 2008, Texas Instruments Incorporated